

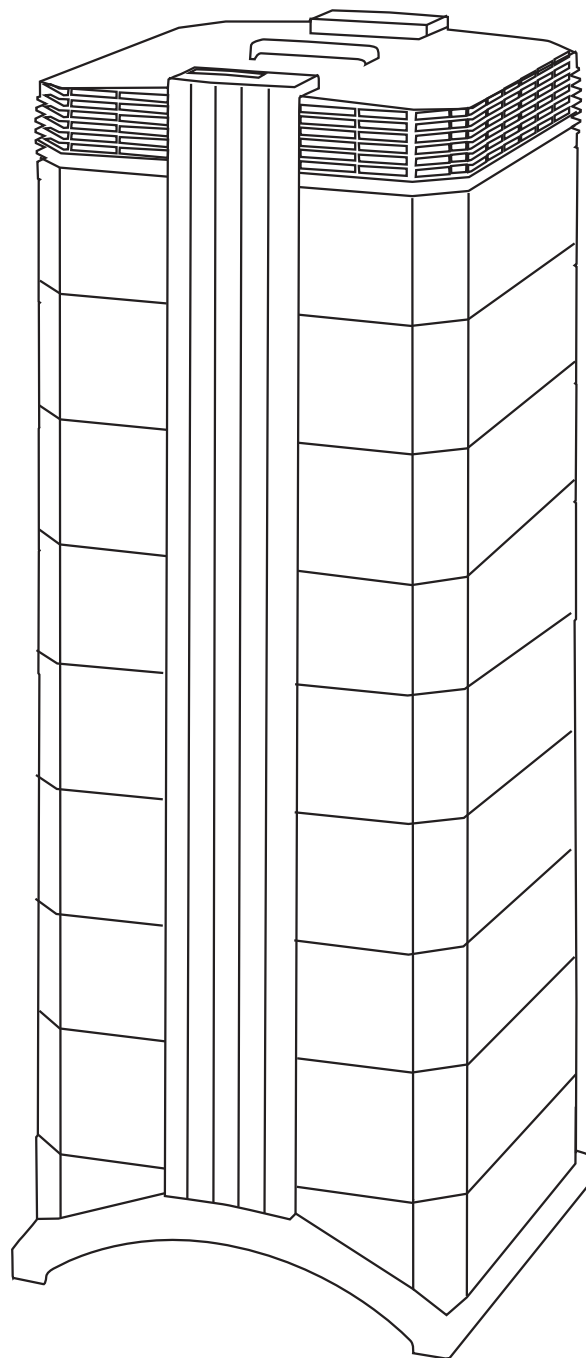

GCX Series

User Manual



 **Swiss Made**

Important Safety Instructions

About This User's Manual

Congratulations on your purchase of this IQAir® high-performance air cleaning system. Please study this user manual carefully to familiarize yourself with the special features and functions of your IQAir system and keep it in a safe place for future reference.

Read these instructions before using the appliance:

- Do not use this appliance as sole protection against harmful pollutants.
- Do not immerse the appliance in water or other liquids.
- Always disconnect the power from your air cleaner by unplugging the power cable before adding or removing parts and before cleaning.
- Do not operate this appliance if it has a damaged cord or plug, if the motor fan fails to rotate, if it is not working properly, if it has been dropped or damaged, or immersed in water.
- If the mains cord of this appliance should become damaged, it may be replaced with a similar cord set, as is commonly used for computers and similar appliances.
- Only use this appliance for its intended purpose of air cleaning in non-industrial environments.
- Do not use this appliance in areas with very high concentrations of dusts or powder to prevent the danger of dust explosions.
- Do not use this appliance in explosive areas.
- Only use filters and accessories recommended by IQAir.
- Do not use outdoors.
- Do not obstruct the air inlet and air outlet of the air cleaner.
- Do not place the appliance on a soft surface such as a bed or other soft furnishings.
- Only use this appliance in an upright position.
- Do not place next to a humidifier.
- Keep the power cord away from heated surfaces.
- Save these instructions for future reference.

This appliance is not intended for use by persons (including children) with reduced physical, sensory or mental capabilities, or lack of experience and knowledge, unless they have been given supervision or instruction concerning the use of the appliance by a person responsible for their safety. Children should be supervised to ensure that they do not play with the appliance.

IQAir® reserves the right to change specifications contained in this document at any time and without prior notice.

© 1998–2012 IQAir® Group. All rights reserved. IQAir® is the registered trademark of the IQAir® Group. EvenFlow™ is a trademark of the IQAir® Group. IQAir® systems and filters are protected under U.S. patents 6 001 145 and 6 159 260. Other U.S., European and Asian patents pending.

| | Page |
|--|-------------|
| Important Safety Instructions | 2 |
| Chapter 1 – Air Cleaning Systems and Indoor Air Quality | 4 |
| 1.1 Improving Indoor Air Quality | 4 |
| | |
| Chapter 2 – Setting Up | 5 |
| 2.1 Unpacking | 5 |
| 2.2 Choosing a Suitable Location | 6 |
| 2.3 Connecting to Power | 6 |
| | |
| Chapter 3 – The IQAir® System’s Components | 7 |
| 3.1 Description of Housing Components | 7 |
| 3.2 Description of Removable Components | 8 |
| 3.3 How the IQAir® System Works | 8 |
| | |
| Chapter 4 – Using the Control Panel | 9 |
| 4.1 Description of Control Panel | 9 |
| 4.1.1 Description of Control Panel Keys | 9 |
| 4.2 Control Panel Locking Function | 10 |
| 4.3 Fan Speed and Air Delivery | 10 |
| 4.3.1 Regulating Fan Speed | 10 |
| 4.3.2 Air Exchange Rates in Differently Sized Rooms | 11 |
| 4.4 Using the Menu Functions | 11 |
| 4.4.1 Menu Overview | 11 |
| 4.4.2 Filter Life Monitor | 12 |
| 4.4.3 Setting the Daily Timer | 13 |
| 4.4.4 Setting the Weekly Timer | 14 |
| 4.4.5 Timer ON/OFF Fan Speed Selection | 14 |
| 4.4.6 Timer Information in the Control Panel | 15 |
| 4.4.7 Time & Day Setting | 15 |
| 4.4.8 Filter Life Reset | 16 |
| 4.4.9 Changing Airflow Units | 16 |
| 4.4.10 Language Setting | 16 |
| 4.4.11 Filter Load Index Setting | 17 |
| 4.4.11.1 Determining the Filter Load Index | 17 |
| 4.4.11.2 Modifying the Filter Load Index | 18 |
| | |
| Chapter 5 – Using the Remote Control | 19 |
| 5.1 Remote Control Functions | 19 |
| 5.2 Getting the Best Transmission Results | 19 |
| 5.3 Placing Batteries in the Remote Control | 20 |
| | |
| Chapter 6 – Replacing Filters | 20 |
| 6.1 Location of the Filters | 20 |
| 6.2 Ordering Replacement Filters | 20 |
| 6.3 Opening and Closing the Housing | 21 |
| 6.3.1 Troubleshooting when Closing the Housing | 21 |
| 6.4 Replacing the Pre-Filter (Filter 1) | 21 |
| 6.5 Replacing the Gas Phase Filter Cartridges (Filter 2 & 3) | 22 |
| 6.6 Discarding Used Filters | 23 |
| | |
| Chapter 7 – Maintenance | 23 |
| 7.1 Cleaning the Housing | 23 |
| 7.2 Maintenance-Free Fan | 23 |
| | |
| Chapter 8 – IQAir® Accessories (Optional) | 24 |

Chapter 1 – Air Cleaning Systems and Indoor Air Quality

1.1 Improving Indoor Air Quality

Air cleaning can play an important role when it comes to improving indoor air quality. However, it should be noted that air cleaning should be used in conjunction with pollution source control and ventilation, wherever possible.

Strategy to improve indoor air quality

To tackle any indoor air quality problem, keep the following three-step strategy in mind:

1. Eliminate or reduce the air pollution source as much as possible. Source control is by far the most effective way to improve indoor air quality, since it sets out to deal with air pollution at the point of origin.
2. Ensure that sufficient fresh air is entering the room from outside. Air cleaners are not a substitution for sufficient ventilation. They are not able to reverse the conversion of oxygen (O₂) into carbon dioxide (CO₂), caused by breathing and combustion processes.
3. Ensure the IQAir system can clean enough air to cope with your room size. The actual hourly air volume cleaned by the system should be at least double the air volume of your room. If the rate at which pollutants enter the room air is high or the indoor air quality requirements are stringent, the hourly air delivery of the system needs to exceed the room air volume several times. To achieve that level of air turnover, it may be necessary to employ more than one system.

Air Cleaning Results

Although air cleaners may be advertised and sold to be suitable for use in specific indoor environments and to deal with specific indoor air quality problems, the manufacturer and distributors make no claim as to the specific air cleaning results that are achieved under the user's individual operating conditions. The air quality improvements that can be realized with the IQAir system (as with any air cleaner) in indoor environments depends to a significant degree on circumstantial factors, which are out of the control of the manufacturer or distributors. Important factors which will influence the air quality improvements that can be achieved in an indoor environment with an air cleaner include:

- Type of air pollutants present
- Intensity of the pollutant source(s)
- Pollutant concentration
- Size of the indoor environment (room size)
- Operating speed of the unit
- Number of air cleaners placed in the indoor environment
- Saturation state of the filters in the air cleaner

Consult a qualified specialist to determine an effective and comprehensive indoor air quality strategy.

Chapter 2 – Setting Up

2.1 Unpacking

To unpack the IQAir system, open the top of the box and remove the square styrofoam pad which contains all accessories and product literature. Lay the box on its side, hold the system by the handle and pull it out of the box. Remove the plastic bag and foam belt. Keep the packaging for future transport and service needs.

4 post filter sleeves

Note: The sleeves are supplied inside the IQAir system. Pull the post filter sleeves over the cartridges before installing the cartridges in the air cleaner.

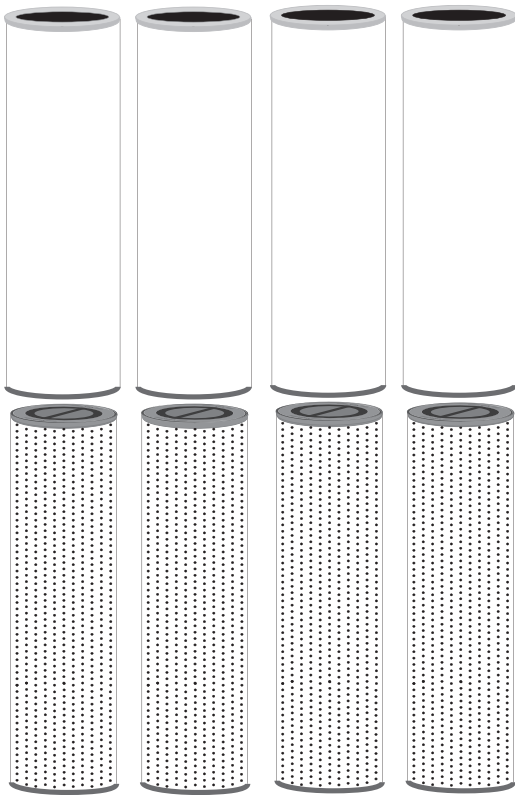

4 gas phase filter cartridges

Note: The gas phase filter cartridges for the air cleaner are supplied in a separate box and must be installed before use.

IQAir®
Advanced Air Cleaning System

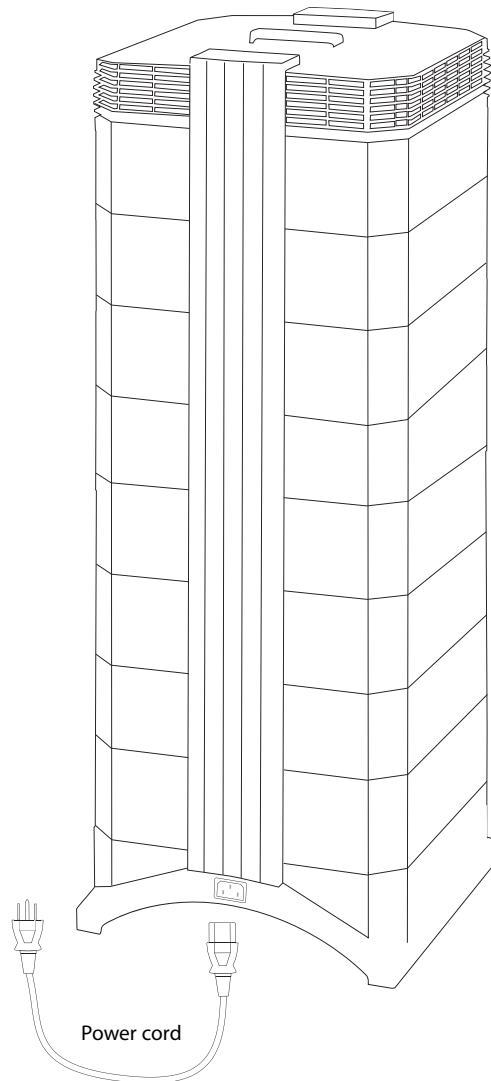

Remote control including battery

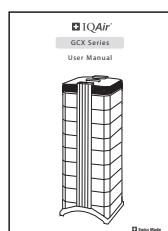

User manual



Certificate of Performance



Warranty Card and Technical Specifications

2.2 Choosing a Suitable Location

When choosing a suitable location for the IQAir system, keep the following considerations in mind:

- Choosing the most suitable room for the system will depend on where you would like the focus of the air cleaning efforts. Two main considerations are the time you spend in a particular room and the location of the main air pollution sources. As a general rule, the closer the system is located to the air pollution source, the better the air cleaning performance in the room. Although an air cleaning result may be achieved in adjacent rooms, the main air cleaning will take place in the room where the system is located. For the best air cleaning results in adjacent rooms, make sure that doors to these rooms are left wide open.
- For best performance, the system should be positioned at least 30 cm (1 foot) away from the nearest vertical surface, such as a wall or a cupboard. In general, the more centrally the system is positioned, the better the performance.
- Position the system close to a power outlet and make sure that the power cable is positioned in a way that it does not present an obstacle that could be tripped over.
- Make sure that the system is positioned in such a way that the control panel is easily accessible.

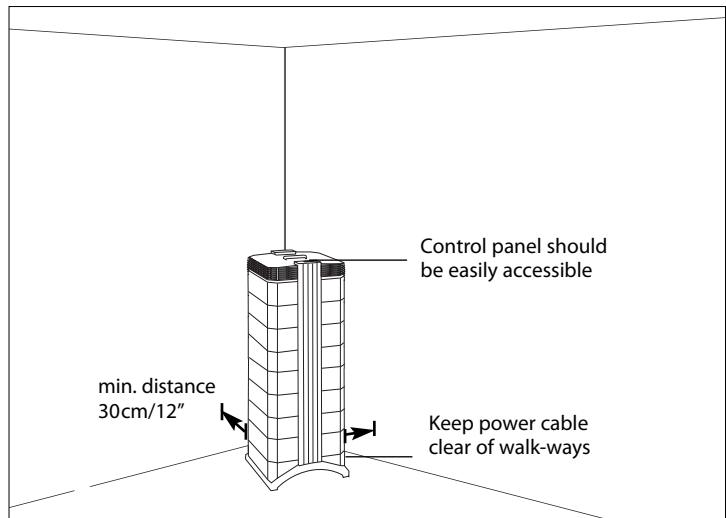

2.3 Connecting to Power

1. Plug the connector end of the power cord into the recessed power inlet socket on the back of the system.
2. Plug the other end of the power cord into a power outlet or power strip.

Important: The only way to disconnect power completely is to unplug the power cord.

Do not use the IQAir system when the power cord becomes damaged. The power cord may be replaced with an approved cord with a two-pole plug. These power cords are commonly used for computers and similar appliances.

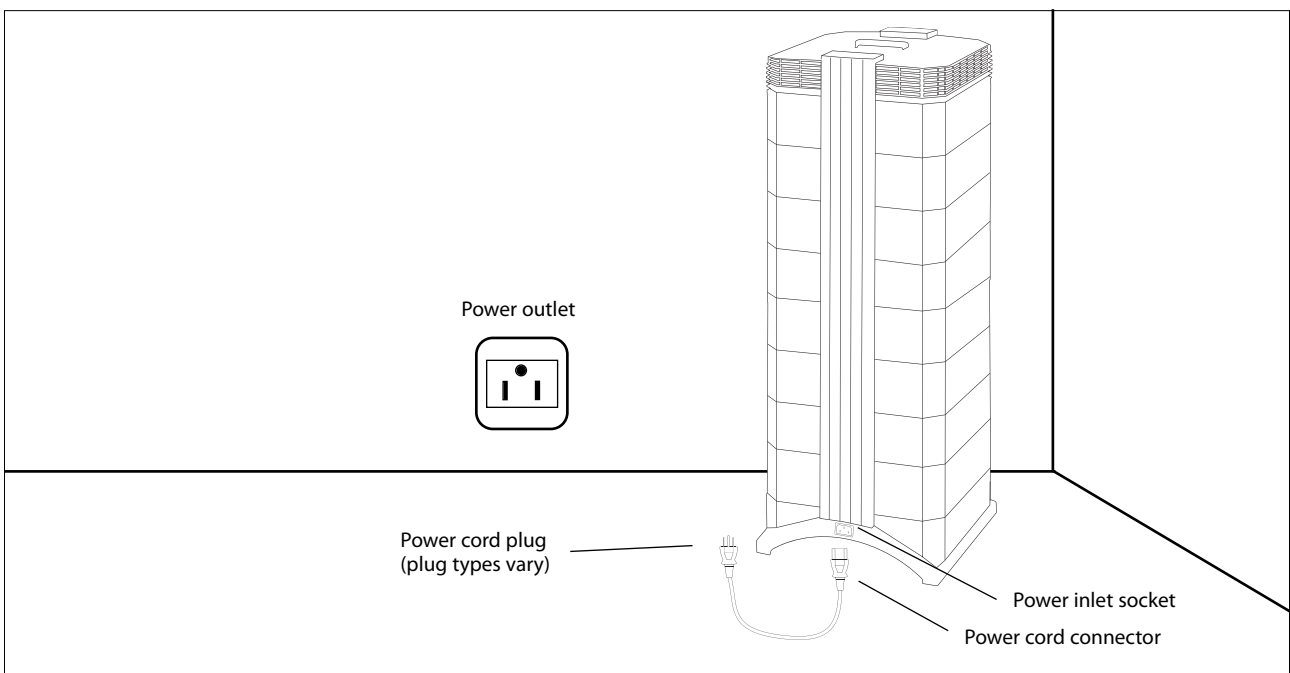

Chapter 3 – The IQAir® System's Components

3.1 Description of Housing Components

The IQAir system features a modular tower design in which all important filtration and air moving components are positioned vertically in-line, i.e. stacked on top of another. Air is drawn into the system at the base, and passes through several filter stages to be returned to the room via the diffuser on top of the system. The housing modules are held together by two locking arms.

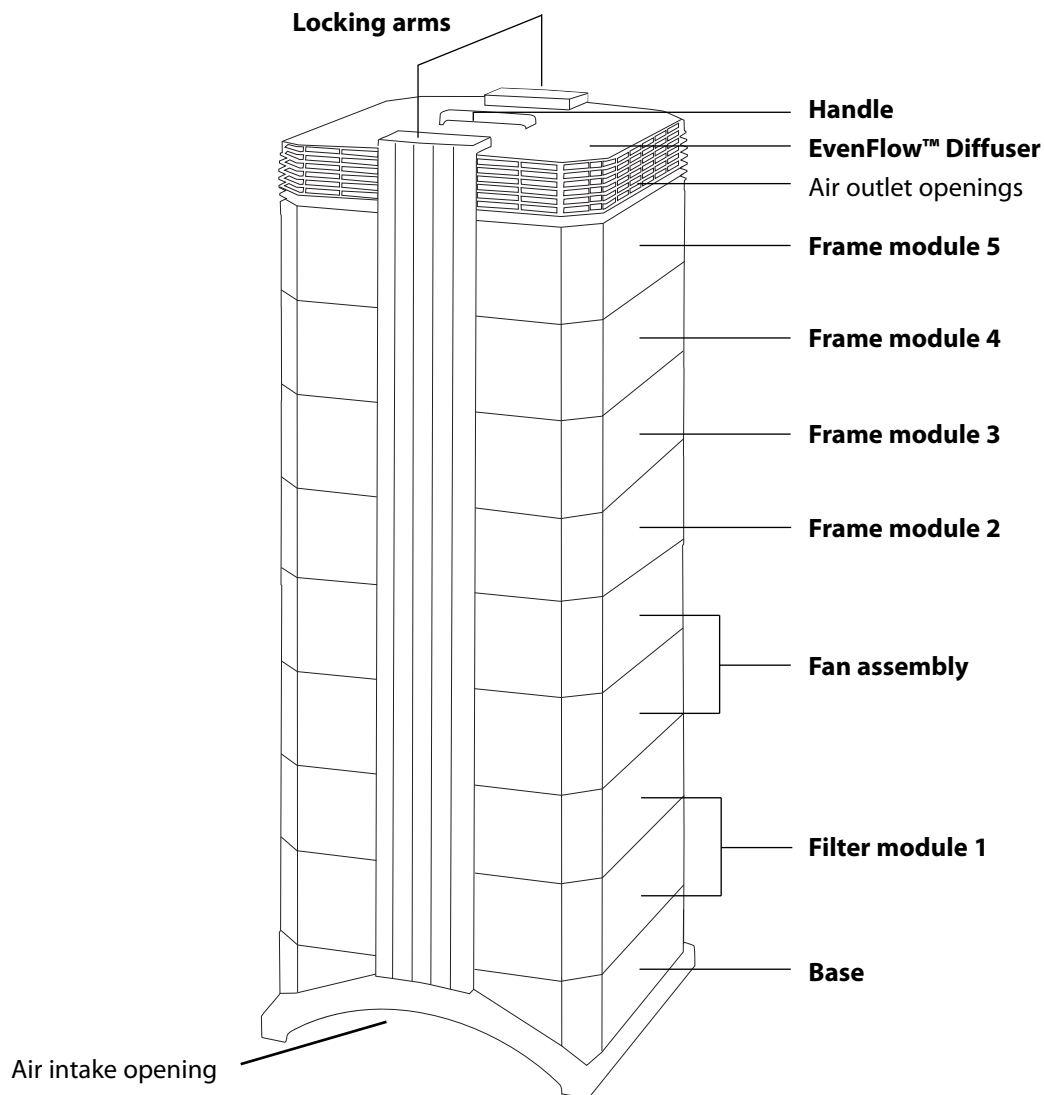

- The **base** with its arched design features air intake openings on two sides.
- The **Frame module 1** consists of frame 1 and the Pre-Filter which is fixed inside the frame by four filter clamps.
- The **fan assembly** comprises two housing modules with the centrifugal fan inside.
- The **Frame module 2** consists of frame 2 and a steel base plate in which the four gas phase filter cartridges are fixed by means of a bayonet locking system.
- **Frame module 3, 4 and 5** cover the 4 gas phase cartridges and filter sleeves.
- The **EvenFlow™ diffuser** features the omni-directional air outlet openings.
- The **handle** on top of the diffuser is designed for carrying the IQAir system.
- The **locking arms** hold the housing elements together. When opened, the locking arms allow easy access to all filters.

3.2 Description of Removable Components

The IQAir system features a modular housing design which enables the easy replacement of all filters in a matter of seconds. The illustration below shows all the removable components. For more details on how to replace filters, please refer to Chapter 6 – Replacing Filters.

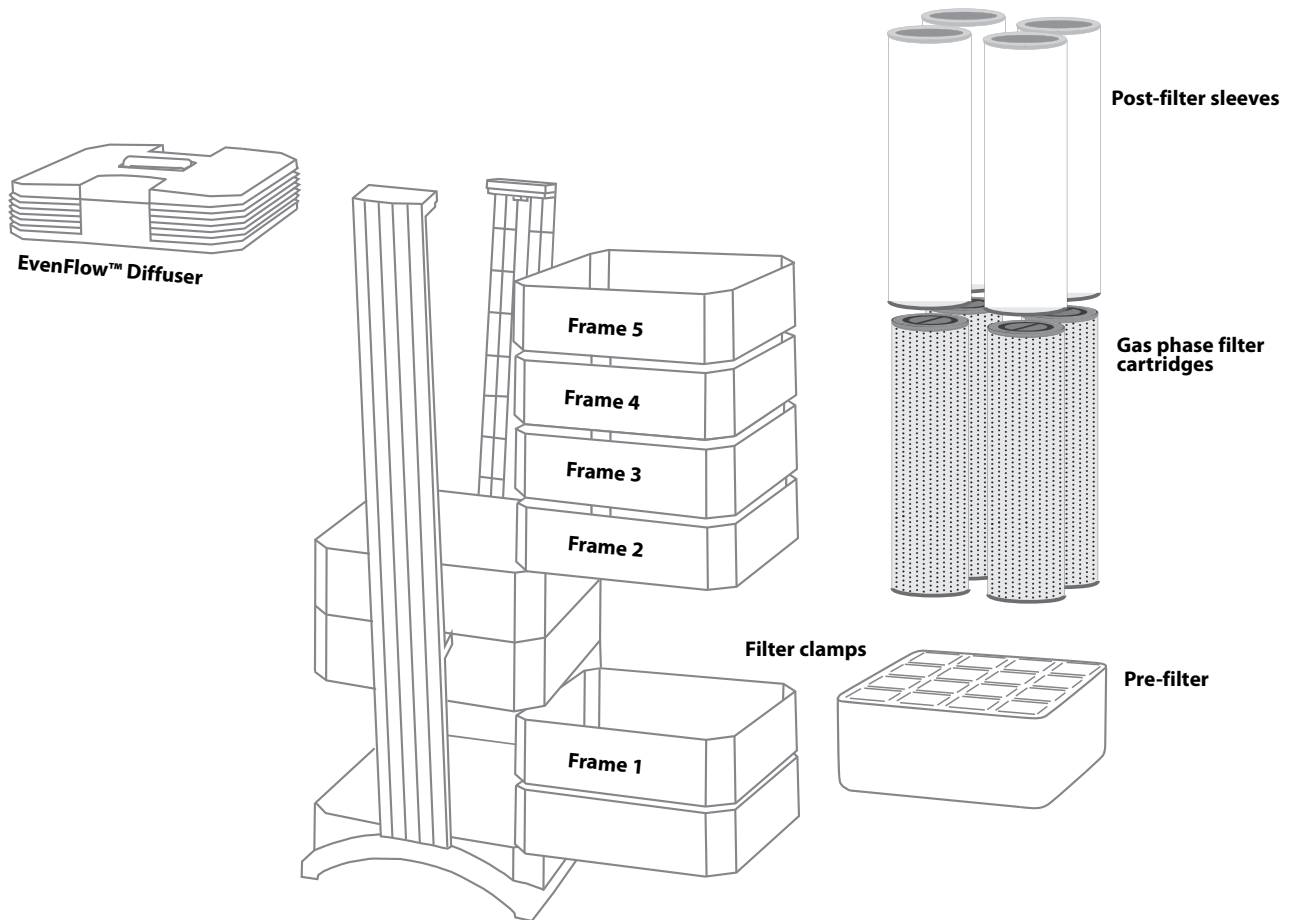

3.3 How the IQAir® System Works

1. Room air is drawn into the system via two arched openings at the base.
2. The air is drawn in through the HEPA pre-filter that already removes most pollution particles.
3. At the heart of the system, sandwiched between the filters, is a powerful centrifugal fan which generates the air flow.
4. The air is pushed through four cartridges that contain up to 14,6 kg of gas phase control media, which retains specific chemical pollutants.
5. Particulate post-filter sleeves hold back abrasion particles from the gas phase filter media.
6. Low turbulence, low velocity air is returned to the room via the EvenFlow™ diffuser.

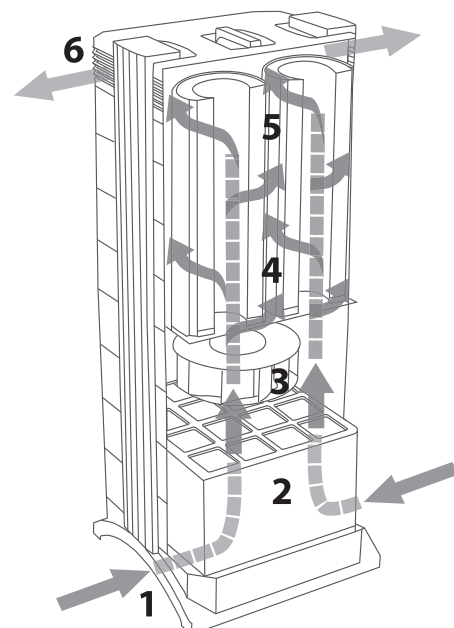

Chapter 4 – Using the Control Panel

The IQAir system is operated and controlled via the electronic control panel which is located at the top of the front locking arm.

Several operations can be completed via the electronic control panel, including:

- Switching the system on and off
- Controlling the fan speed and corresponding air delivery rate
- Checking the remaining filter life of the individual filters
- Setting the automatic timer
- Resetting the Filter Life Monitor after replacing a filter
- Locking the control panel to avoid tampering with the system's settings
- Choosing the desired display language

4.1 Description of Control Panel Elements

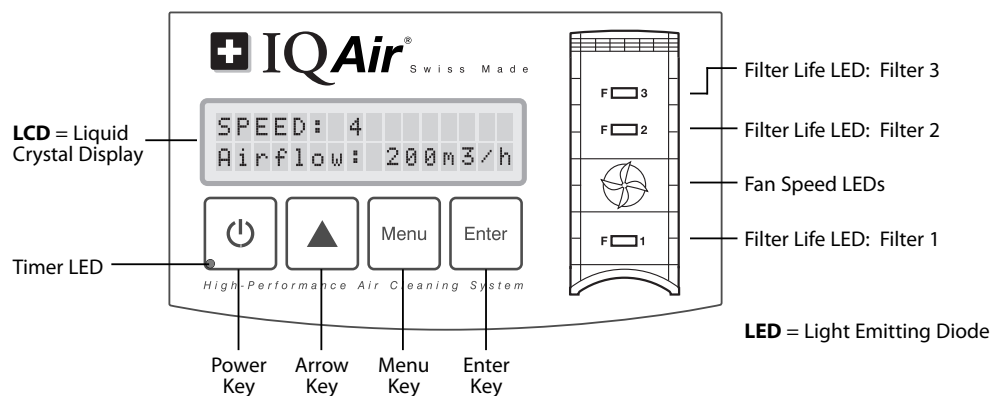

LCD Display

The 2-line LCD displays important information about the system's settings. In standby mode, the first line shows the current day and time. If the timer is activated, the programmed start and stop times will be displayed on the second line.

If the IQAir system is on, the first line displays the current speed setting and the second line displays the corresponding air delivery rate of the system. By pressing the Menu key, ten active menu functions may be accessed. These functions are explained in detail in this chapter.



Main window: Standby mode



Main window: On mode



Menu window: Filter Life monitor

4.1.1 Description of Control Panel Keys



Power Key

The **Power** key switches the IQAir system on and off. When the system is switched off, the fan stops to run, but the system will remain connected to the power supply (standby mode). The standby mode allows for automatic timer start-up. In the standby mode, the different menu functions can be accessed. **Tip:** In a menu window the **Power** key also serves as a quick exit key to return to the main display window.



Arrow (▲) Key

When the system is switched on, the ▲ key allows the adjustment of the fan speed. In the enter mode, indicated by the appearance of a black flashing cursor (see "Enter Key" below), the ▲ key is used to modify the selected setting in the display window. Confirmed with the **Enter** key, the enter mode is automatically terminated. The LCD will then display the current menu settings for another 15 seconds before reverting to the main window display.

Menu Key

The **Menu** key allows access to any one of eleven menus. Pressing the **Menu** key once allows access to the first menu function. Pressing the **Menu** key twice allows access to the second menu function, and so on. If no key is pressed for 15 seconds in a menu window, the display will revert to the main display window. **Tip:** If you are in a menu window and would like to remain in the window for more than 15 seconds, keep the ▲ key depressed.

Enter Key

The **Enter** key, if pressed for 3 seconds, allows the modification of a setting. The enter mode is indicated by a flashing cursor on the modifiable setting. Pressing the **Enter** key again will save any entry and move the cursor to the next modifiable item in the display window. When the last modifiable choice in a window is confirmed with the **Enter** key, the enter mode is automatically terminated and the new settings are saved.

Filter Life LEDs: Whenever the system is on, the colour of the filter life LEDs (light emitting diodes) indicates the state of the individual filters in the system. **Note:** The positions of the filter life LEDs on the control panel correspond to the actual positions of the filters within the system.

The filter life indicator LEDs signal four possible stages in the life of the filter:

- 1. Green:** The filter is still within 80% of its estimated life span.
- 2. Orange:** The filter is approaching the last 20% of its estimated life span.
- 3. Red:** The filter has reached the end of its estimated life span.
- 4. Red blinking:** The filter has passed its estimated life span and should be replaced immediately. The IQAir system’s effectiveness is likely to have been reduced dramatically, either due to a reduction in airflow (particle filters are clogged) or a reduction in filter efficiency (gas phase filter is saturated).

Fan Speed LEDs: These LEDs simulate the fan speed through the frequency of their rotation. The faster the rotation of the fan speed LEDs, the faster the actual fan speed of the unit.

4.2 Control Panel Locking Function

The control panel can be locked to avoid tampering with the settings. To lock or unlock the control panel keys, the **Menu** and the **Enter** key have to be pressed down simultaneously for 3 seconds. The activated locking function is indicated with a star symbol in the control panel display. The locking function is cancelled by disrupting the power supply.

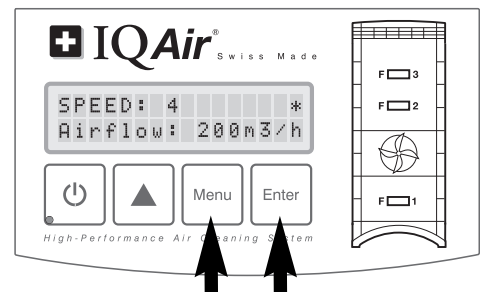

4.3 Fan Speed and Air Delivery

The IQAir system can be set to run at six different fan speeds which correspond to six different airflow rates. Speed 1 is the lower, speed 6 the highest fan speed. The higher the fan speed, the more room air will be filtered by the system. The high fan speed settings provide additional air cleaning power to deal with situations of elevated pollution levels. The standard display window shows not only the fan speed, but also the air delivery rate (airflow). The displayed airflow is factory preset and is not measured by the system itself.

4.3.1 Regulating Fan Speed

- 1. When the IQAir system is switched off (standby mode), the first line of the LCD display shows the model name. To switched the system on, press the **Power** key on the far left of the control panel.
- 2. The LCD now displays the fan speed and the corresponding airflow rate. **Note:** The system starts at the fan speed at which it was running when it was last used.
- 3. To change the fan speed, press the ▲ key.

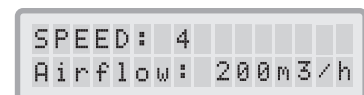

4.3.2 Air Exchange Rates in Differently Sized Rooms

Any air cleaner can only be effective if it filters a sufficient amount of air in an indoor environment. For general air cleaning purposes, the IQAir system should be able to filter the room air volume at least twice every hour on the set fan speed to achieve a significant air quality improvement. If the intensity of the pollution source is high or a high degree of purification is needed, more air changes may become necessary. In order to achieve the desired number of air changes, more than one air cleaner may be required. The number of air changes that are necessary to attain a certain level of indoor air quality will depend on a variety of factors, including:

- **intensity of air pollution source:** The higher the rate at which air pollutants are produced or enter the indoor environment, the higher the air cleaning rate in the room needs to be.
- **filtration efficiency for specific air pollutants:** The lower the filtration efficiency for certain pollutants, the more air changes are required to reduce these pollutants.
- **desired improvement in air quality:** The higher the desired improvement in air quality, the more air changes are required.

The number of ACH produced by an IQAir system in a specific environment are calculated as follows:

$$\frac{\text{hourly air delivery of the IQAir system (m}^3\text{/h)}}{\text{air volume of the room (m}^3\text{)}} = \text{air changes per hour (ACH)}$$

N.B. The air delivery rates of the IQAir system at the various fan speeds settings are listed on the “Technical Specifications” sheet.

Example calculation: A room with the dimensions of 4 x 4 x 2.6 meters has an air volume of 41.6 m³. With an air delivery rate of 240 m³/h, the room air volume will be circulated over 5.7 times per hour by the IQAir system (240 m³/h ÷ 41.6 m³ = 5.77 ACH).

4.4 Using the Menu Functions

The IQAir control panel offers a choice of several menu options which allow access to the advanced features of the system. In total there are ten active menu functions. The functions can be accessed in standby or running mode.

4.4.1 Menu Overview

Pressing the **Menu** key accesses the menu functions in the following order:

1. Filter Life Monitor

Allows the viewing of the remaining filter life of the individual filter elements within the system.

```
REMAINING LIFE
Filter 1: 400h
```

2. Daily Timer

Allows to activate the timer and set the daily ON period.

```
AUTO TIMER: OFF
00:00 → 00:00
```

3. Weekly Timer

Allows to deactivate the daily ON period on certain days of the week.

```
Mo Tu W T F S Su
* * * * * *
```

4. Timer ON Fan Speed Selection

Allows to set the fan speed for the Timer ON period.

```
Timer ON Speed:
4
```

5. Timer OFF Fan Speed Selection

Allows to set the fan speed outside the Timer ON period.

```
Timer OFF Speed:
0
```

6. Time & Day Setting

Allows to set the current time and day setting.

```
TIME 00:00
DAY Mo
```

7. Filter Life Reset

Allows the resetting of the filter life counter after replacing a filter element.



8. Airflow Units

Allows to switch the airflow units between cfm (cubic feet per minute) and m³/h (cubic meters per hour).



9. Language

Allows the modification of the display language.



10. Filter Load Index Setting

Allows the modification of the air pollution index, so the system can calculate the remaining filter life, taking pollution intensity into account.

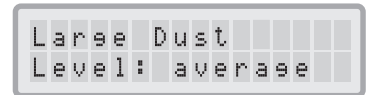

11. Service Access

This menu is designed for factory access only.



4.4.2 Filter Life Monitor

The IQAir system is equipped with an electronic Filter Life Monitor that calculates the remaining life of the system’s filters. Thanks to the Filter Life Monitor, the user does not have to guess when filters need to be replaced or replace them at fixed intervals (which rarely correspond to the actual amount of use). The Filter Life Monitor watches over the most important factors affecting the life of the individual filters. The Filter Life Monitor display shows the remaining life of each individual filter at any given time.

1. To reach the Filter Life Monitor display from the main display window, press the **Menu** key once. The remaining life of the filter 1 will appear.
2. Press the **▲** key to view the remaining life of the other filters in the system.
3. The remaining life of the filters is expressed in hours of operation at the current speed setting and the programmed filter load indices.

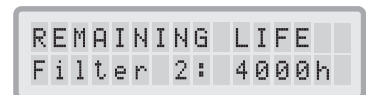
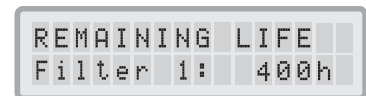

How the Filter Life Monitor Works

The basis for the calculation of the remaining filter life is the already elapsed operation time at the set fan speeds and filter load indices during that period. This input is compared with an internal memory bank which contains information about the different filters’ lives under specific conditions of use.

The Filter Life Monitor makes a calculation of the remaining filter life, taking into account not only past use of the system, but also likely future use. As reference for future use, the filter life monitor uses the fan speed and the filter load indices which are programmed at the time.

The relationship between the current fan speed, the current filter load indices and the remaining filter life displayed can be expressed as follows:

- The higher the current fan speed setting, the shorter the displayed remaining filter life.
- The higher the current filter load index setting, the shorter the remaining filter life displayed for the affected filter.

4.4.3 Setting the Daily Timer

The Daily Timer Menu allows the setting of a Timer ON period, which is defined by a start time and an end time. For the Timer ON period, a fan speed can be selected in the Timer ON Fan Speed Menu (see 4.4.5). The time outside the Timer ON period is defined as the Timer OFF period for which the air cleaner can be switched off or for which a different fan speed can be selected in the Timer OFF Fan Speed Selection Menu (see 4.4.5).

The timer status field indicates whether the timer function is enabled or disabled and allows the user to quickly enable/disable the timer e.g. for holiday.

1. To reach the Daily Timer Menu from the main display window, press the **Menu** key twice.
2. Press and hold the **Enter** key until the cursor starts to flash.
3. Press the **▲** key once to activate the timer. **Note:** If the start and stop time are identical, the timer cannot be activated.
4. Press the **Enter** key to save the timer status setting and to proceed to the start time.
5. Select the desired start hour by pressing the **▲** key.
6. Press the **Enter** key to save the start hour and to proceed to the minute setting.
7. Select the desired start minute setting by pressing the **▲** key. **Note:** The minute settings can only be set in five minute increments.
8. Press the **Enter** key to save the start time and to proceed to the stop time setting.
9. Select the desired stop hour by pressing the **▲** key.
10. Press the **Enter** key to save the stop hour and to proceed to the minute setting.
11. Select the desired minute setting by pressing the **▲** key.
12. Press the **Enter** key to save the minute setting and to exit the enter mode

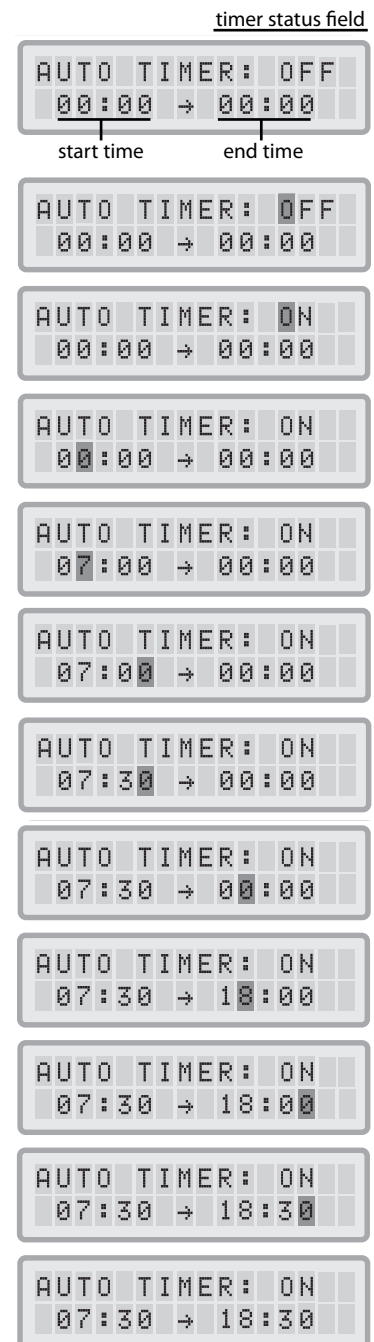

4.4.4 Setting the Weekly Timer

The weekly timer allows the activation/deactivation of the Timer ON period on certain days of the week. In its default setting the timer is enabled on all seven days of the week. This is indicated by stars below the abbreviations of the days. On days, without a star, the air cleaner will be running at the speed which is set in the Timer OFF Fan Speed Selection Menu (see 4.4.5).

Note: At least one day of the week must be enabled with a star to be able to run the daily timer. If the timer is disabled on all days of the week, the timer status field in the Daily Timer Menu will switch to "OFF" and the timer will be disabled.

1. To reach the Weekly Timer Menu from the main display window, press the **Menu** key three times.
2. Press and hold down the **Enter** key until the cursor appears.
3. Press the **▲** key to activate (star) or deactivate (no star) the daily time on a particular day. Press the **Enter** key to proceed to the next day.
4. Repeat the same procedure until the timer has been activated/deactivated on the desired days. The final **Enter** command exits the enter mode.

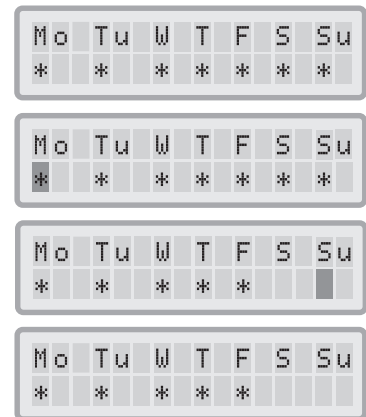

4.4.5 Timer ON/OFF Fan Speed Selection







The Timer ON/OFF Fan Speed Selection Menu allows the programming of two different fan speeds for two different time periods (referred to as Timer ON and Timer OFF periods). For the Timer ON period you can select between fan speeds 1 to 6. For the Timer OFF period you can select between fan speeds 0 (i.e. off) to 6.

1. To reach the Timer ON Fan Speed Selection Menu from the main display window, press the **Menu** key four times.
2. Press and hold the **Enter** key until the cursor appears.
3. Press the **▲** key to select the desired speed for the Timer ON period.
4. Press the **Enter** key to confirm the chosen speed and to exit the enter mode.
5. To set the fan speed for the Timer OFF period press the **Menu** key one more time. Press the **Enter** key until the cursor appears and adjust the Timer OFF fan speed as above. The final **Enter** command saves the selection exits the enter mode.

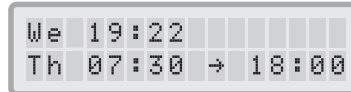

4.4.6 Timer Information in the Control Panel

The IQAir control panel informs about the timer status without the need to access the Timer menu windows. When the timer is activated, the second line of the display's main window shows the selected start and the stop times. In addition, the timer LED will show a green light when the timer is activated. When the timer is not activated, the timer LED will show a red light (in standby mode) or no light (in running mode).

| | Timer LED | Display's Main Window | |
|--|--|---|--|
| <p>Timer Deactivated When the system is switched off (standby), the timer status LED is red.</p> |  |  | <ul style="list-style-type: none"> • Timer is deactivated • System is on standby |
| <p>When the system is running, the timer status LED is not lit.</p> |  |  | <ul style="list-style-type: none"> • Timer is deactivated • System is running |
| <p>Timer Activated When the timer is activated, the timer status LED is green and the second line of the display shows the day and the time the system will next switch Timer ON to Timer OFF period.</p> |  |  | <ul style="list-style-type: none"> • Timer activated • System is on standby |
| |  |  | <ul style="list-style-type: none"> • Timer is activated • System is running. |

4.4.7 Time & Day Setting

When the IQAir system is first connected to the power, the day and time displayed will be incorrect and will have to be set, for the timer function to work properly. Once the current day and time are set, they will only need to be reset if the unit is disconnected from the power supply for more than an hour.

1. To access the Time & Day function from the main display window, press the **Menu** key six times.
2. Press and hold the **Enter** key until the cursor starts to flash.
3. Select the hour by pressing the **▲** key.
4. Press the **Enter** key to save the hour setting and to proceed to the minute setting.
5. Select the minutes by pressing the **▲** key.
6. Press the **Enter** key to save the minute setting and to proceed to the day setting.
7. Select the day of the week by pressing the **▲** key.
8. Press the **Enter** key to save the day setting and to exit the enter mode.
9. Press the **Power** key to return to the main display. **Note:** The display will automatically return to the main window if no key is pressed for 15 seconds.

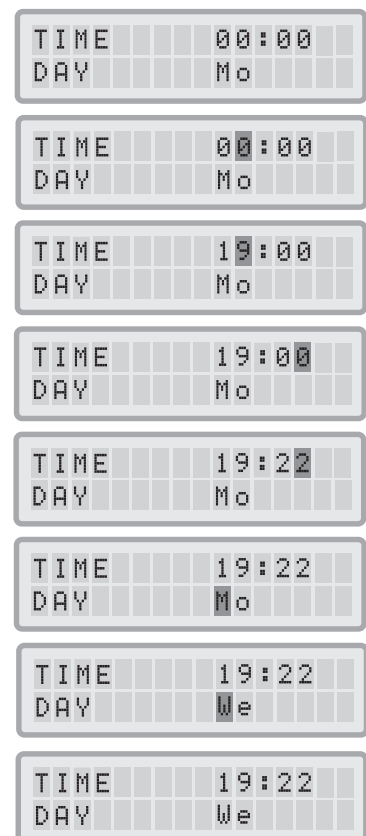

4.4.8 Filter Life Reset

The Filter Life Reset function allows the filter life counter to be reset after a new filter has been inserted. As a result, the appropriate filter life LED on the control panel will be reset to green and the hour count in the Filter Life Reset display will be reset to the full life span of the new filter.

1. To reach the Filter Life Reset function from the main display window, press the **Menu** key seven times.
2. Press and hold the **Enter** key until the flashing cursor appears.
3. Press the **▲** key to select the filter that has been replaced.
4. Press the **Enter** key to confirm that the selected filter has been replaced. To safeguard against inadvertently resetting the life of the wrong filter, the selection needs to be reconfirmed. The Filter Life LED for the appropriate filter is now flashing red. **Note:** If the wrong filter has been selected, or if you wish to exit the enter mode, press the **Menu** key. This leaves the Filter Life Reset unaffected.
5. To confirm the filter change and exit the Filter Life Reset display window, press the **Enter** key.
6. Upon successful reset of the filter life, the new remaining filter life (taking the currently selected fan speed and programmed filter load indices into account) will be displayed.

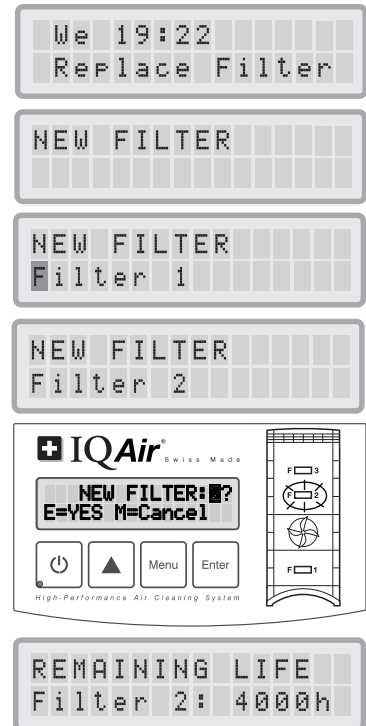

4.4.9 Changing the Airflow Units

N.B. The air delivery (airflow units) displayed in this manual are examples only and will vary according to model.

1. You can change the air volume units from cubic feet per minute (cfm) to cubic meters per hour (m³/h), and vice versa, by pressing the **Menu** key eight times and then the **Enter** key for three seconds.
2. When the first character of the air volume units starts to flash, press the **▲** key once to change the units.
3. Press the **Enter** key to confirm the air volume unit change. Until modified again, the airflow rate will now be displayed in the newly selected units.



4.4.10 Language Setting

The Language Menu Display allows to change the system's display language.

1. To reach the Language Menu Display from the main display window, press the **Menu** key ten times. The current display language is displayed.
2. To change the display language, press and hold the **Enter** key until the cursor starts to flash.
3. Use the **▲** key to scroll through the display language options.
4. Press the **Enter** key to save the desired display language and to exit the enter mode.



4.4.11 Filter Load Index Setting

The filter load indices are used by the filter life monitor for a more accurate calculation of the remaining filter life. The filter load indices are based on air pollutant groups that have particular impact on the life of the IQAir system's filters. Each index can be adjusted to reflect the pollution levels in a certain indoor environment.

The Filter Load Index Menu allows to view and modify the filter load indices for:

- Large Dust
- Chemicals
- Fine Dust



Large Dust Index: This index is based on the group of coarse or heavy dust. This dust can contain particles with several millimeters in length down to particles a mere 0.003 mm in size. This type of dust will generally settle within an hour after generation or agitation on top of surfaces. It consists of fibers, pollen, spores, dander, wood dust, etc.

Chemical Index: This index is based on the group of gaseous organic compounds. These are organic chemicals that are present in the air in the form of gas molecules. This group includes solvents, hydrocarbons, such as benzene, formaldehyde, perchlorethylene, styrene, toluene and xylene.

Fine Dust Index: This index is based on the group of fine dust particles. This type of dust is smaller than 0.003 mm (3 µm) in size and will remain airborne for long periods of time. This dust group is made up of small combustion particles that are created as the result of combustion processes of automobiles, small allergen particles such as cat allergens, tobacco smoke particles, etc.

4.4.11.1 Determining the Filter Load Index

The setting for each of the filter load indices can range from “very low” to “very high”. The system is supplied with the following default settings:

- Large Dust Index: average
- Chemical Index: average
- Fine Dust Index: average

There are a number of factors that may make a modification of the default settings necessary in order to ensure the most accurate filter life display possible.

Tobacco Smoke

The amount of tobacco smoke in the room air can have a significant effect on filter life. If tobacco smoke exposure is regular, the filter load indices for each pollutant group should be adjusted to “high” or “very high”.

Presence of Gases and Chemicals

Gases and chemicals may be set free from solvents, paints, varnishes and from vehicle or industrial emissions, as well as pesticides. Such pollutants influence the life of the gas and odour filter in the IQAir® system. If there is a regular presence of gases and chemicals, it is recommended to increase the Chemical Index to “high” or “very high”.

Dusty Environments

Environments with a high dust levels are likely to shorten the lives of the pre-filter and the HEPA-filter. If there is a frequent high dust content in your environment, set the Large Dust Index to “high” or “very high” (Tobacco smoke exposure should not be used for the definition of a “dusty environment”).

4.4.11.2 Modifying the Filter Load Index

The Filter Load Index menu allows the adjustment of individual pollution indices to reflect the actual pollution levels in a particular environment more closely. This enables the Filter Life Monitor to perform a more precise calculation of the remaining filter life.

1. Press the **Menu** key nine times to reach the Filter Load index menu.
2. Press and hold the **Enter** key until the cursor appears.
3. Press the **▲** key to modify the Large Dust index to reflect the large dust pollution levels found in the environment where the system is used (for guidance, see previous section).
4. Press the **Enter** key to save the Large Dust index setting.
5. Press the **▲** key to proceed to the Chemical index.
6. Press and hold the **Enter** key until the cursor appears.
7. Press the **▲** key to modify the Chemical index to reflect the chemical pollution levels found in the environment where the system is used (for guidance, see previous section).
8. Press the **Enter** key to save the Chemical index setting.
9. Press the **▲** key to proceed to the Fine Dust index.
10. Press and hold the **Enter** key until the cursor appears.
11. Press the **▲** key to modify the Fine Dust index to reflect the fine dust pollution levels found in the environment where the system is used (for guidance, see previous section).
12. Press the **Enter** key to save the Fine Dust index setting.

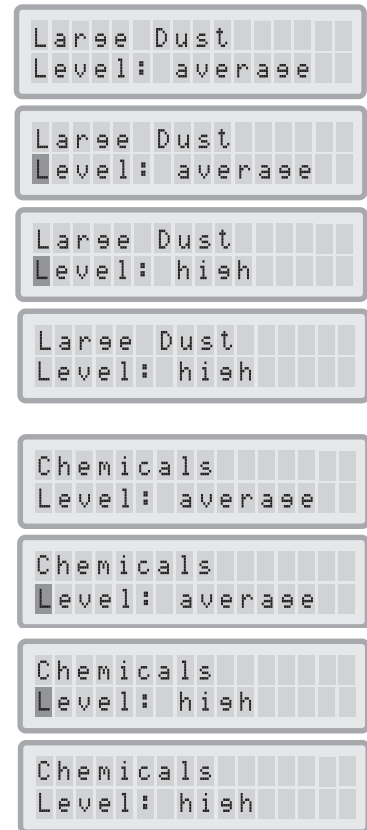

etc.

Limitations of Filter Load Indices

The concept of filter load indices allows for a more precise calculation of the remaining filter life than with regular filter life counters. Yet, the determination of filter load indices underlies in its definition some natural limitations. For this reason it may become necessary to change filters before the expiry of the indicated filter life, especially if there is a noticeable decrease in filtration performance. In such a case, it may be necessary to adjust the appropriate filter load settings to a higher value.

Chapter 5 – Using the Remote Control

In addition to the control panel, the IQAir system can be controlled by using the hand-held remote control.

The remote control can be used to:

- Switch the system on and off
- Select the desired fan speed
- Activate and deactivate the timer function (Note: Start and stop times can only be set and changed directly on the system's control panel)

5.1 Description of Remote Control Elements and Functions

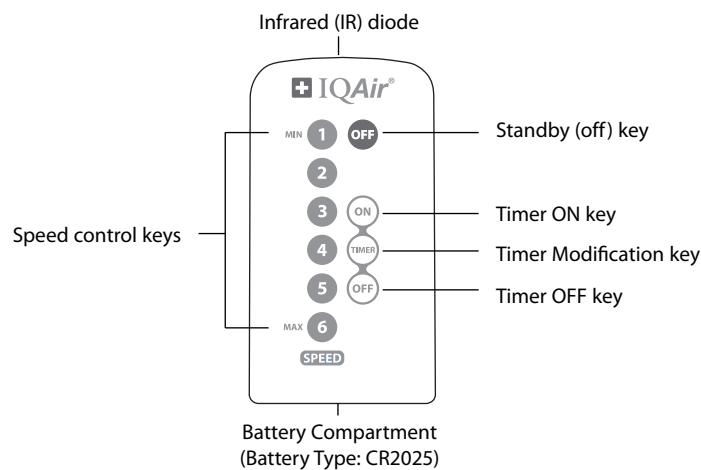

Switching the System On and Off: To switch the IQAir system on with the remote control, press any one of the **speed control** keys marked with 1, 2, 3, 4 etc. To switch the IQAir system off, press the **OFF** key.

Switching the Timer On and Off:

If start and stop times have been set in the Daily Timer Menu, it is possible to switch the timer on and off with the remote control. To switch the timer on, press the **Timer Modification** key and then the **Timer ON** key. To switch the timer off, press the **Timer Modification** key and then the **Timer OFF** key.

5.2 Getting the Best Transmission Results

The IR (infrared) receiver of the IQAir system is positioned underneath the control panel cover. In order to get the best signal transmission, the remote control should be pointed at the control panel when a remote command is being carried out. Alternatively, the remote control should be pointed at a surface like a wall, ceiling or window, from which the signal can bounce off in a right angle (90°) to the electronic control panel.

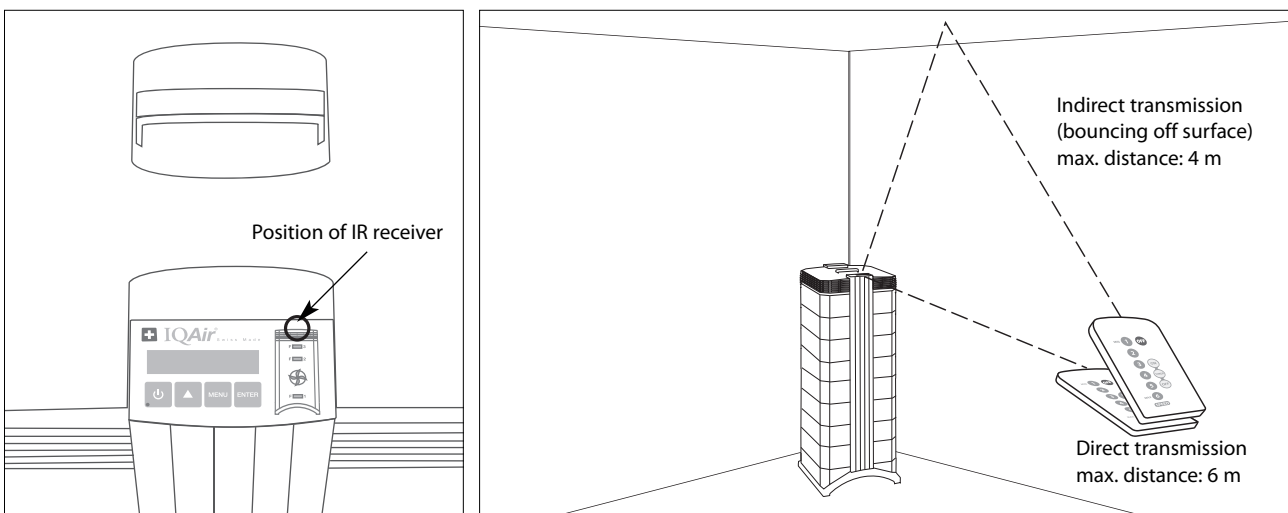

5.3 Replacing the Battery of the Remote Control

When the battery becomes weak, the transmission results will deteriorate and the battery should be replaced. The remote control requires one CR2025 battery. The battery compartment is located at the bottom end of the remote control.

To open the battery compartment, press the small lever to the side and slide the battery compartment out. Remove the used battery and insert the new battery.

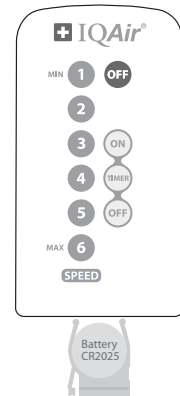

Chapter 6 – Replacing Filters

The IQAir system is equipped with a filter life monitor which is designed to assist you in determining when a filter needs to be replaced. If the pollution load is high and the filter load indices are not set appropriately, there is a possibility that the filter may not be effective throughout the displayed life time.

For this reason it is important to look out for the signs of used up filters. The main signs are:

- Increased operating noise
- Decreased airflow
- Clogged filter
- Increased odour presence

6.1 Location of the Filter Elements

The IQAir system features a modular housing design which enables easy replacement of all filters in a matter of minutes. The illustration of the IQAir system on the right side of the control panel shows the positions of the individual filters. These positions correspond to the actual positions of the filters within the system.

6.2 Ordering Replacement Filters

Please order the replacement filter elements from your point of purchase by quoting the name and the article number of the filter. Both can be found on the label of the individual filter element.

6.3 Opening and Closing the Housing

The stacked housing elements are held together by two locking arms that hook into the diffuser. To open the system follow the steps below.

1. Disconnect the IQAir system from the power supply before attempting to open the unit.
2. Press the first locking arm outward, using both thumbs as shown. Press just hard enough to release the arm from its snap-in position in the diffuser. Disengage the other arm in the same way.
3. Pull both locking arms evenly outwards until they snap into place and remain open. Access to all filter elements is now possible (to change a specific filter, refer to the appropriate section below).

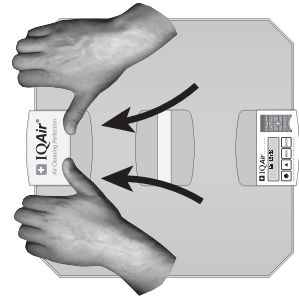

4. To close the housing, simply push the locking arms inwards simultaneously until they snap back into the housing.

Opening

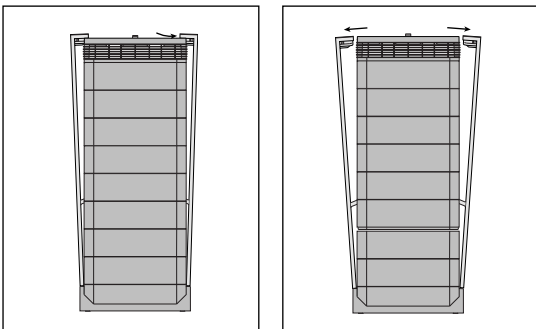

Closing

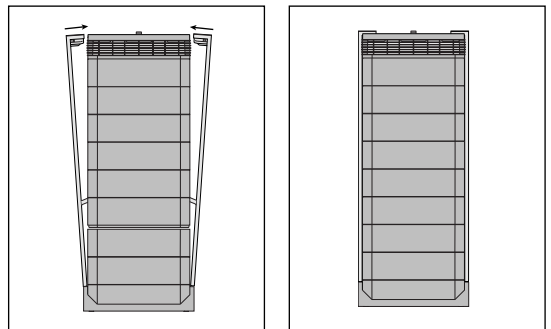

6.3.1 Troubleshooting when closing the Housing

If the IQAir system does not close properly, the upper part of the system may be offset against the lower part. To solve this problem, simply open both locking arms again and push both locking arms in simultaneously.

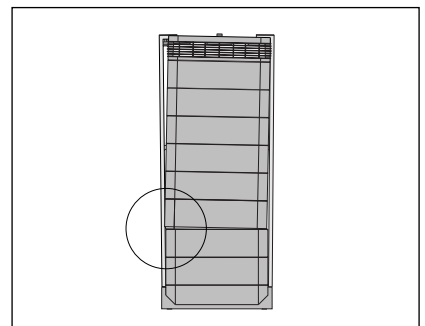

6.4 Replacing the HEPA PreFilter (Filter 1)

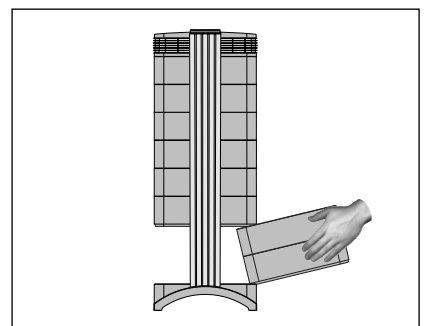
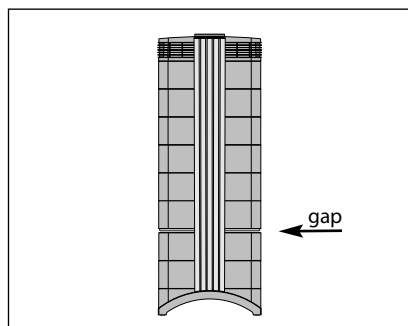
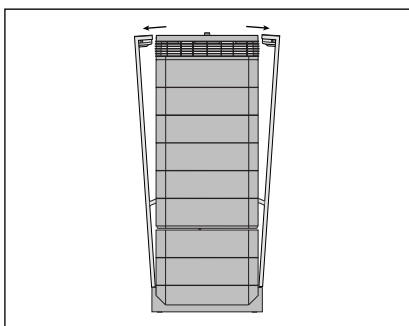

1. Open the locking arms, making sure they are fully extended outward. For details, refer to the section 6.3.
2. Opening the arms will cause the upper part of the housing to separate from frame 1. This will leave a narrow gap.
3. Place your hands on opposite sides of frame 1, lift it slightly and pull it out slowly. As the frame is withdrawn from the system, tilt it progressively upward to remove it completely.

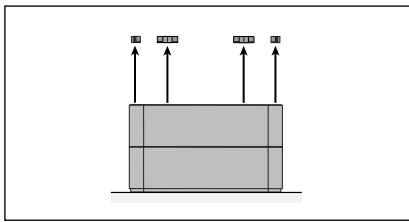

4. Remove the filter clamps that secure the filter in the frame, by pulling these out of the sliding grooves.

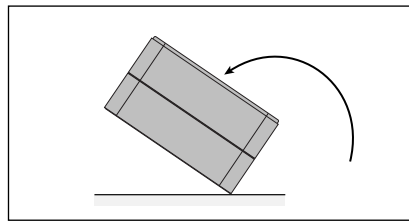

5. Turn the frame upside down.

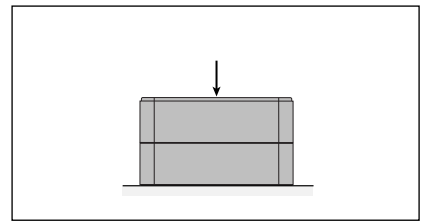

6. With the palm of the hand, press down on the filter and loosen the frame.

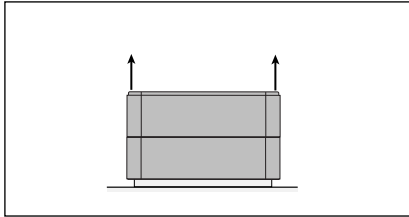

7. Lift the frame from the filter.

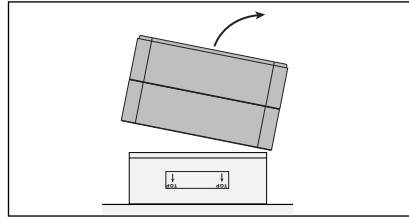

8. Dispose of the used filter by placing it into the plastic bag in which the new filter is supplied.*

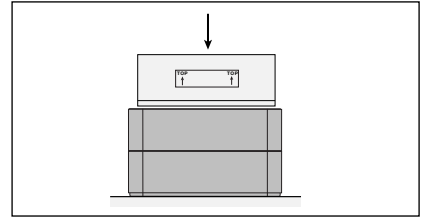

9. Turn the frame around and insert the new filter. Ensure that the arrows on the filter label point upward.

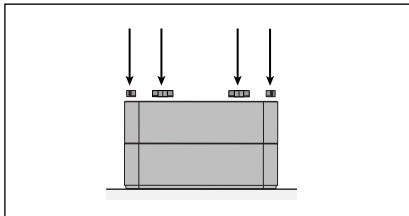

10. Make sure that the filter is inserted all the way into the frame. Insert the clamps into the sliding grooves inside the frame and push them down.

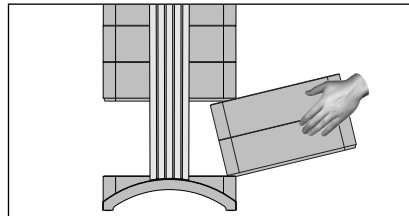

11. Put the frame back into the housing. For details on how to close the housing, please refer to the section 6.3.

Important: After a filter has been replaced, the filter life monitor must be reset (see section 4.4.8).

* If harmful substances are filtered, disposal of the used filters may be subject to local regulations or laws.

6.5 Replacing the Gas Phase Filter Cartridges and Post-Filter Sleeves (Filter 2 & 3)

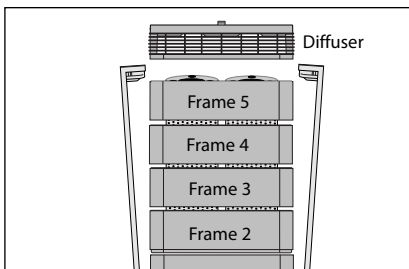

1. Open the locking arms, remove the diffuser and frame 3, 4 and 5.

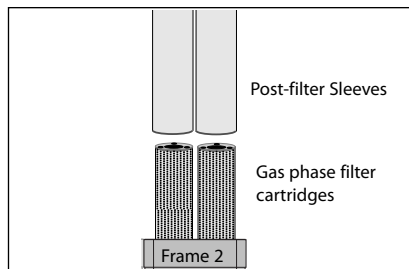

2. Frame 2 contains the four gas phase filter cartridges with the four post-filter sleeves. Remove frame 2 with the cartridges.

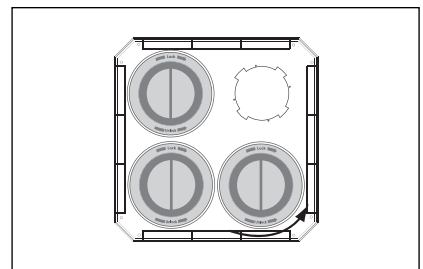

3. Twist each cartridge counter clockwise as far as it will go. It can then be lifted out of the base plate by hand.*

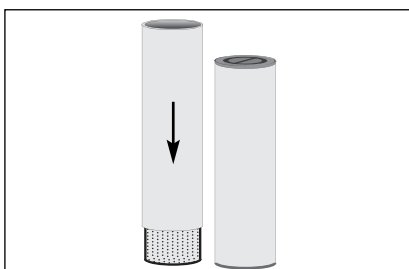

4. Pull a new filter sleeve over each new cartridge until it is completely covered.

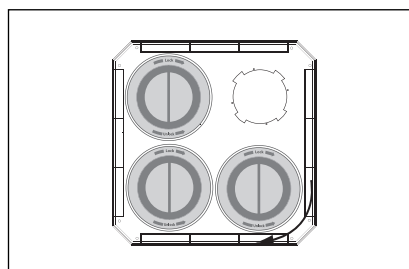

5. Insert the new cartridges in the base plate by turning the cartridge clockwise. Finally check that each cartridge is well secured in the base plate.

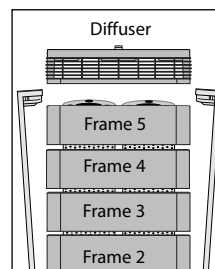

6. Replace frame 2 with the cartridges, frame 4 and 5 and diffuser. Close the unit by pressing both arms together.

Important: After a filter has been replaced, the filter life monitor must be reset (see section 4.4.8).

6.6 Discarding Used Filters

Used filters can normally be put into the regular household waste for disposal. If the system may have been exposed to potentially hazardous substances the filters may have to be disposed of as hazardous waste. Please refer to local regulations and laws.

Chapter 7 – Maintenance

7.1 Cleaning the Housing

- Unplug the IQAir system before attempting to clean it.
- Use a soft and clean cloth for cleaning.
- For water soluble stains, use a window cleaning fluid.
- For the removal of tough, non water soluble stains, use a silicon spray.
- Do **not** use any solvents or any organic cleaning fluids.

7.2 Maintenance-Free Fan

The IQAir system is equipped with a maintenance-free fan motor.

Chapter 8 – IQAir® Accessories (Optional)

IQAir advanced air cleaning systems can be complimented with a range of special IQAir accessories. Ask your authorised IQAir® dealer for details.

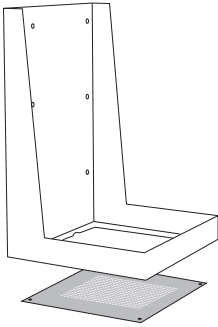

VMF™
Powder-coated stainless-steel wall bracket for the secure wall-mounting of the IQAir® system where floor space is limited.

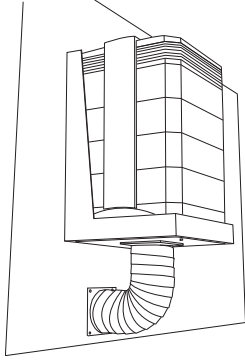

VM InFlow™
Wall-mounted ducting adapter kit for the creation of positive pressure (if placed within the room) and negative pressure areas (if placed outside the room).

InFlow™
Complete ducting adapter kit for the creation of positive pressure (if placed within the room) and negative pressure (if placed outside the room).

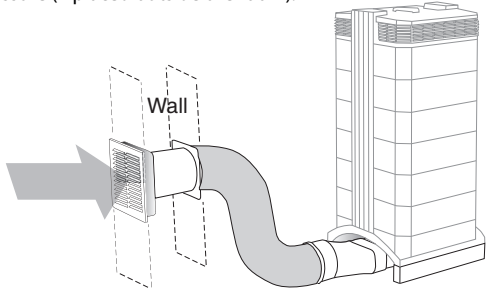

Wall

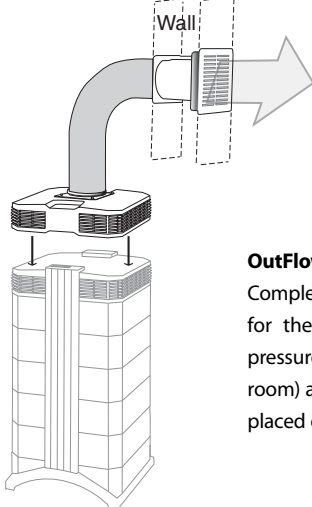

Wall

OutFlow™
Complete ducting adapter kit for the creation of negative pressure (if placed within the room) and positive pressure (if placed outside the room).

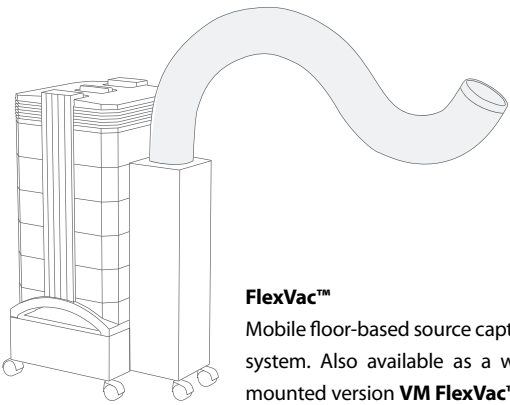

FlexVac™
Mobile floor-based source capture system. Also available as a wall-mounted version **VM FlexVac™**.

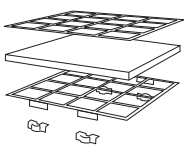

PF40™
Additional pre-filter for areas with high levels of coarse dust.

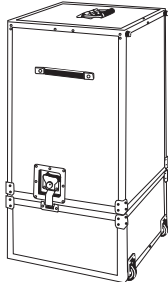

ATC™
Aluminum transport case with wheels for the easy and safe transport of IQAir® systems.